



RockNeo Q1 Series

Robotic Lawn Mower User Manual

Read this user manual carefully before using this product and store it properly for future reference.



Original instructions.

This is a multilingual manual prepared with English as the base language. In case of any discrepancies between the English and other language versions, the English version shall prevail.

Images are for illustration purposes only and may not exactly represent the product.

English	02
Français	14
Español (Latinoamérica)	27

English

Contents

03	Product Overview
07	Preparation and Installation
09	Ready for Mowing
09	Maintenance
11	Long-Term Storage
11	Troubleshooting
12	Technical Data
13	Environment Protection Information
13	FCC/IC Statement

Product Overview

⚠ The mower is pre-installed with blades at its bottom. Always wear protective gloves when lifting the mower, and ensure the blade side is facing outward.

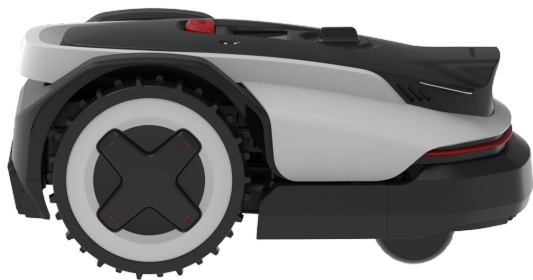

Mower

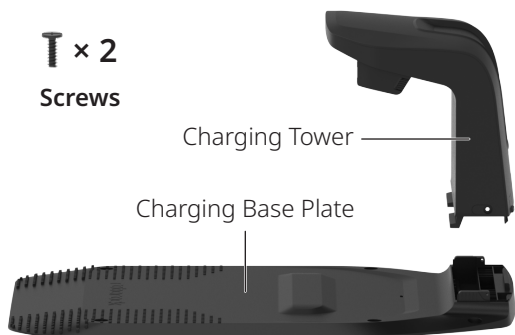

Charging Station

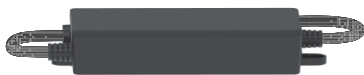

Battery Charger

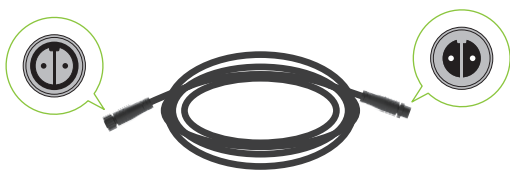

Extension Cable for Battery Charger



RTK Extension Cable

T × 1
Screw

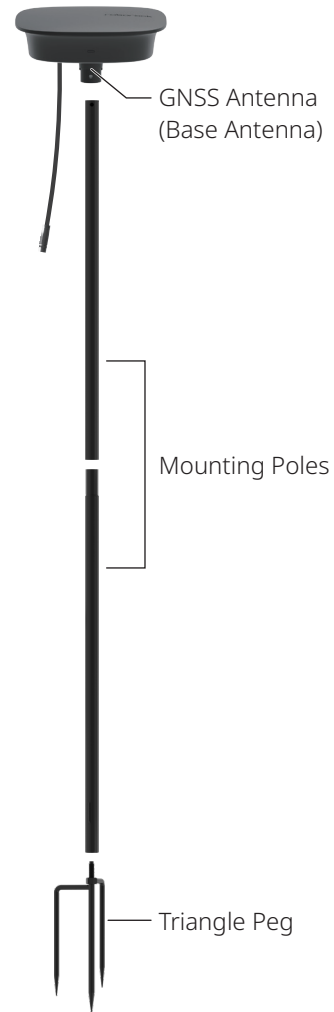

RTK Reference Station



Hex Key



Screws for Charging Station



Pegs for Extension Cable



Cable Clips



Spare Blade Kit

Robotic Mower (Top View)

EN



Robotic Mower (Bottom View)

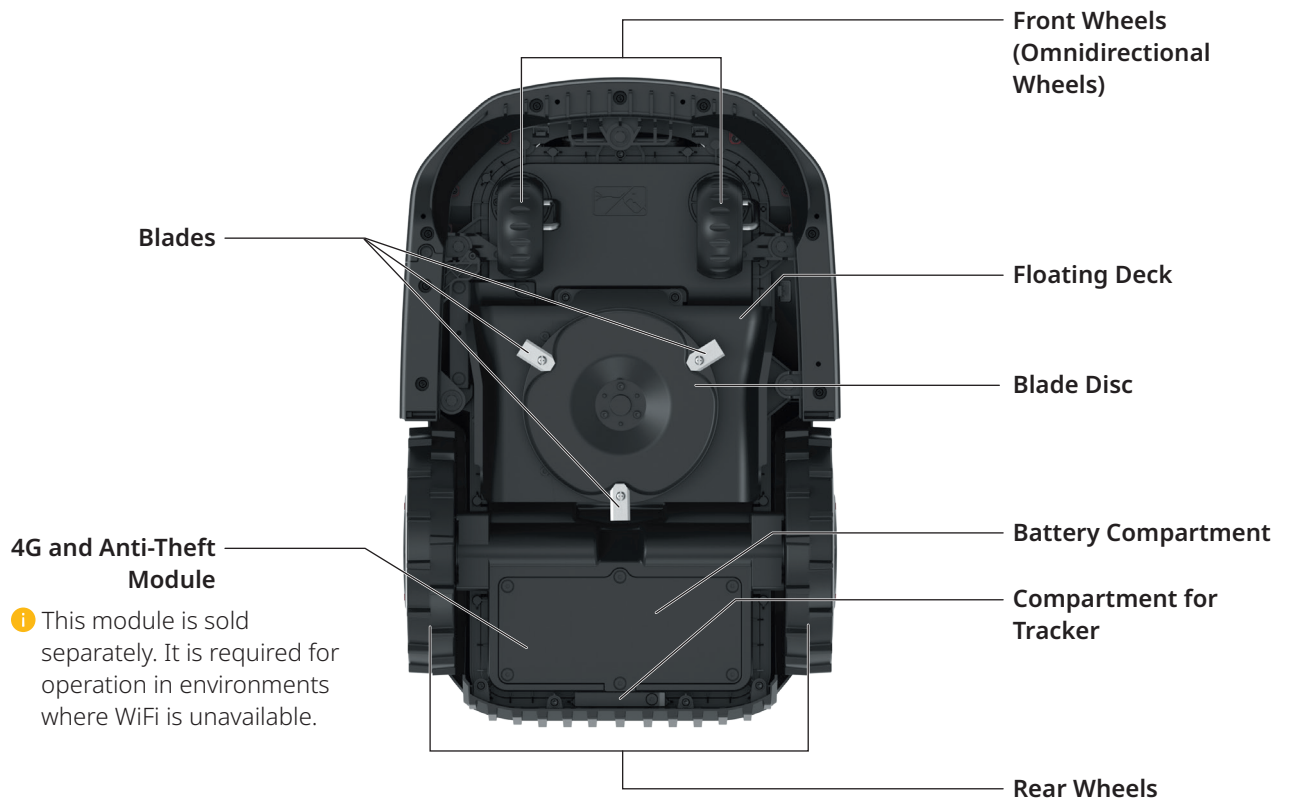

User Interface

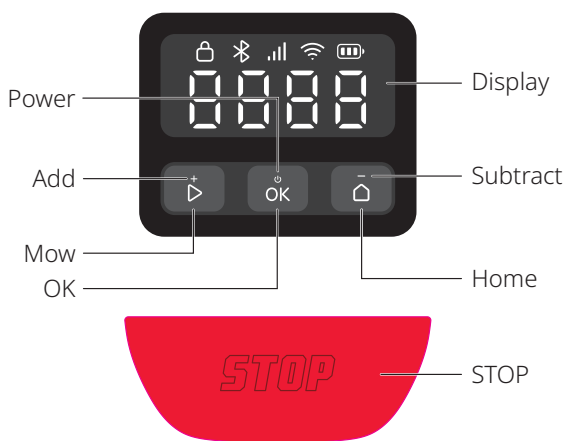



Icon and display	Description
	Battery Level
	4G <ul style="list-style-type: none"> On: 4G available Off: No signal/4G and anti-theft module not installed Flashing: 4G and anti-theft module error
	WiFi <ul style="list-style-type: none"> On: Connected Off: No signal/Not connected Flashing: Waiting for WiFi connection Flashing quickly: Connecting
	Bluetooth <ul style="list-style-type: none"> On: Connected Off: Disconnected
	Lock <ul style="list-style-type: none"> On: Mower locked Off: Mower unlocked Breathing: Typing PIN code
	STOP Mower stopped.
	OTA Over-the-air (OTA) updating.
	Error code A code like this indicates the mower has encountered an error. You can refer to "Error" article at https://garden-support.roborock.com or from the section on the Roborock app for solutions.

Icon and display	Description
	Powering on/off The outer segments rotate clockwise in a continuous loop.
	Charging The display will show battery level in digits.
	Mowing/Mapping/Returning The four digits form a pattern as shown in the diagram. Each segment of the pattern lights up sequentially. Once the full pattern is displayed, the sequence repeats.
	TILT Mower tilted.
	LIFT Mower lifted.

Control

Control	Description
Power on/off	Press and hold for 3 seconds.
Start mowing	Press and then confirm with .
Stop the mower	Press .
Send the mower back to the charging station	Press and then confirm with .
Lock the mower	Press and hold for 5 seconds.
Unlock the mower	Press any button, then enter the PIN code.
Pair the mower	Press and hold and simultaneously for 3 seconds.
Restore factory settings	Press and hold , , and simultaneously for 10 seconds, and then enter the PIN code.
Restart the mower	Press and hold for 10 seconds.







How to Enter PIN Code

Enter the PIN code to unlock the mower before operating. The default code is 0000, you can change the code via the app. Press  or  to increase or decrease the number and press  to confirm each digit.

Note: Please keep the PIN code secure and do not disclose it to others.



Indicators on Charging Station and RTK Reference Station

Indicator position	Indicator status	Description
Charging station	 Steady green	Mower uncharged.
	 Breathing green	Mower is charging.
	 Steady red	Charging station error.
	/ Off	<ul style="list-style-type: none"> Mower fully charged. Circuit fault.
RTK reference station	 Steady green	Strong RTK signal.
	 Breathing orange	Poor RTK signal.
	 Flashing orange quickly	Searching for signal.
	 Breathing red quickly	Error occurred.

Sensors

Sensor	Description
Binocular camera	Senses its surroundings, performs different actions in response to various objects ahead, and runs fusion algorithms with other sensors.
GNSS antenna	Uses GNSS for precise positioning, enabling the mower to accurately determine its location.

How It Works

Your robotic lawn mower can automatically switch between mowing and charging. It does not require a boundary wire to define its working area, due to its centimeter-accurate RTK positioning system and smart mapping with a binocular camera. With a multi-sensor fusion algorithm, the mower intelligently navigates corners and avoids obstacles.

Auto Docking

The mower automatically returns to the charging station when it runs low on power. After charging for a while, the mower will resume mowing.

All Day Cut

The camera's fill light enables the mower to operate at night. You can also set the mower to be wildlife-friendly via the app.

Schedule

You can set your mowing schedule in the app, and the mower will operate automatically according to it.

Cutting Height

Before starting mowing, make sure your grass is no longer than your regular maintenance height. The mower offers multiple adjustable cutting heights. If you want to drastically shorten the height of your grass, it is recommended that you do so step by step.

Planned Route

The mower follows a parallel route generated by a routing algorithm, ensuring higher efficiency and leaving users more time to enjoy their lawn.

Smart Obstacle Avoidance

With its binocular camera, the mower can detect and identify various types of objects, execute different routes accordingly, and balance safety and mowing coverage.

Rain Sensor and Rain Delay

The mower is IPX6-rated water-resistant and built for outdoor use. However, mowing wet grass may not deliver the best results. The mower is equipped with a rain sensor which detects rain and tells the mower to stop mowing and go back to its charging station. It then re-starts mowing after Rain Delay time (180 min by default). You can change the Rain Delay time setting via the app.

Floating Deck

The mower's floating deck allows the mower to dynamically adapt to changes in terrain, ensuring a more even and consistent cut across uneven surfaces.

No Need to Collect Grass Clippings

The short clippings left behind do not need to be raked or collected, as they serve as natural fertilizer for your lawn.

PreciEdge Module

 This module needs to be purchased separately.

With its innovative dual-blade design, the mower can cut close to walls, reducing manual edging.

Anti-Theft

The mower comes with a built-in high-pitched alarm. It also includes a compartment for tracker where you can install a tracker (sold separately). Additionally, you can purchase a 4G and anti-theft module.

Preparation and Installation

Prepare the App

1 Download the App

Scan the QR code to install the Roborock app.



2 Prepare Your Phone

Before proceeding, make sure your phone's Bluetooth is turned on, which is essential for finding and linking your mower during the setup process.

3 Connect the Mower

1. Press and hold **OK** for 3 seconds to power on the mower and enter the PIN code. The default code is 0000.
2. Open the Roborock app.
3. Scan the QR code on the mower via the app or press and hold the **▶** and **⏻** buttons simultaneously for 3 seconds to connect.

Notes:

- We recommend connecting to a 2.4 GHz WiFi network.
- Ensure your mower is within Bluetooth connectable distance (6 m/19.69 ft).

Prepare the Lawn

Before mowing, cut your lawn to its regular maintenance height. Remove any debris, toys, wires, stones, or other obstacles. Ensure that children and pets are kept off the lawn.

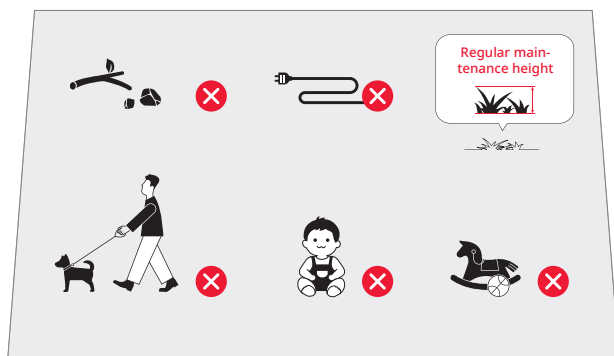

Install the Charging Station

Find a Proper Location

It is important to choose a suitable place for the charging station to ensure effective docking of the mower. See guide below:

1. The charging station should be placed on a flat surface in an open area and close to the battery charger (within 10 m/32.81 ft).

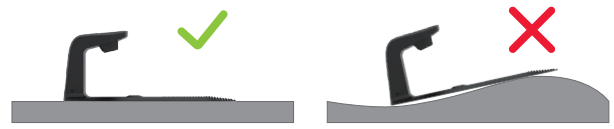

2. We recommend you place the station where the WiFi signal is strong.



3. Within a 2-meter (6.56 feet) radius around the charging station, there should be no obstacles, and the grass should be less than 8 cm (3.15 in) high.

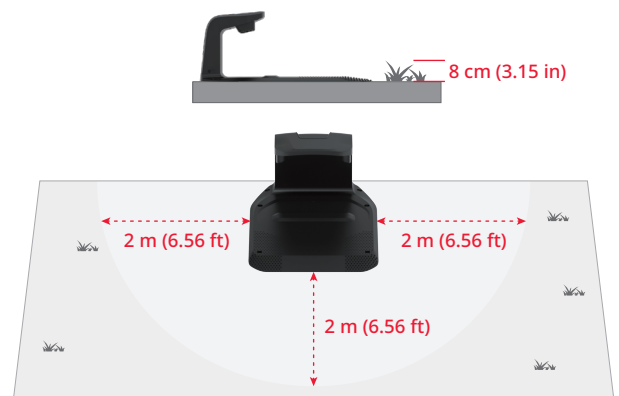

4. The docking markers on the charging tower should be clear.

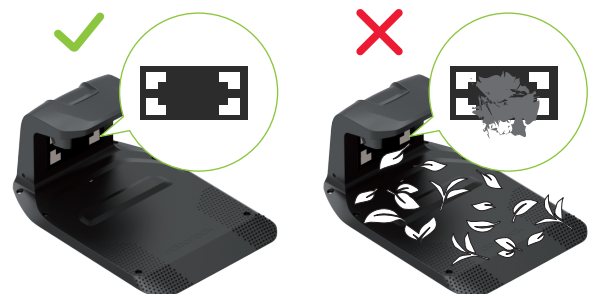

Install the Charging Station

1. Insert the charging tower into the charging base plate. Tighten the screws on both sides of the charging tower, as shown in the picture below.



2. Secure the charging base plate to the ground using the provided screws and hex key.

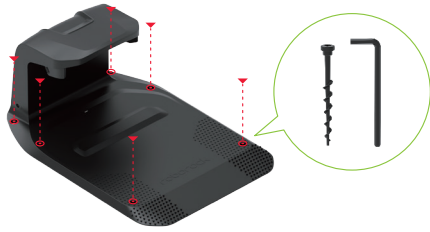

3. Use the extension cable to connect the charging station to the battery charger. You need to align the 2-pin connector, insert it fully, and tighten the locking ring to finish connecting.

4. Connect the battery charger to the power outlet.

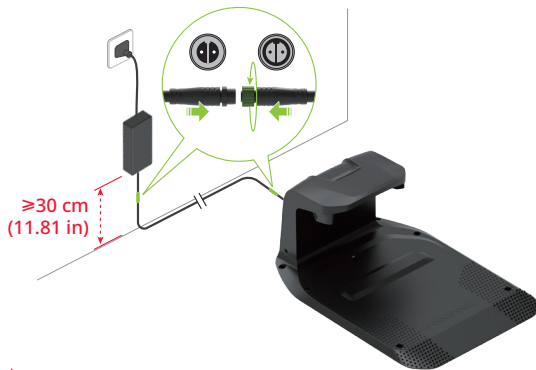

Notes:

- If you need to disconnect the extension cable, loosen the locking ring first, then pull out the connector.
- Ensure the battery charger is positioned at least 30 cm (11.81 in) above the ground to prevent water or moisture damage.
- Plug the device into an indoor outlet or an outdoor waterproof outlet.

5. If the setup is correct, the indicator on the charging station will light green.



Install the RTK Reference Station

Find a Proper Location

The RTK reference station provides high-precision positioning signals to the mower. To ensure stable signal reception, place the RTK reference station in an open area, at least 2 meters (6.56 feet) away from walls or fences.

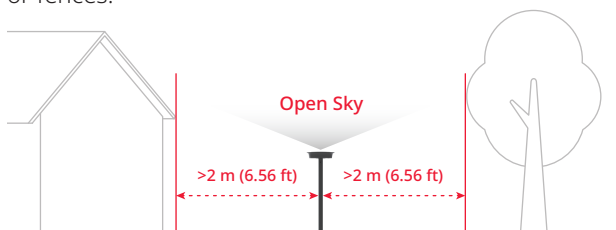

▲ Secure all components of the RTK reference station in case of storms or strong winds.

Install the RTK Reference Station

▲ The triangle peg may cause injury. Handle with care.

1. Assemble the two mounting poles.
2. Tighten the triangle peg as shown in the picture.
3. Screw the mounting pole onto the triangle peg until it is securely tightened.
4. Firmly insert the mounting pole into level ground, ensuring it remains upright.

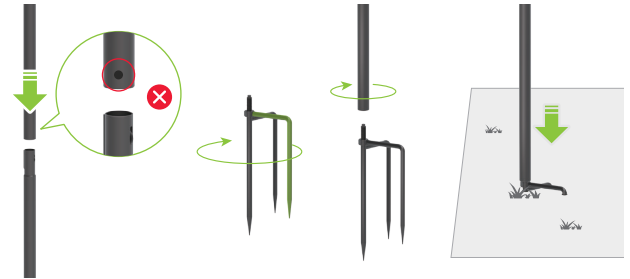

5. Insert the GNSS antenna into the mounting pole and fix it with a screw.



6. Use the RTK extension cable to connect the GNSS antenna to the charging station as shown in the picture.

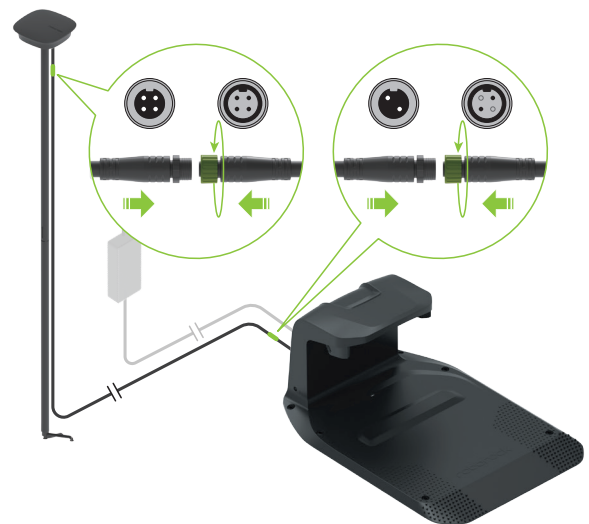

Note: If you want to disconnect the extension cable, loosen the locking ring first, then pull out the connector.

7. When working properly, the indicator on the RTK reference station will be steady green.



- Use the provided cable clips to fasten the extension cable to the mounting pole, and secure it to the ground with pegs. Make sure the pegs are fully inserted into the ground.

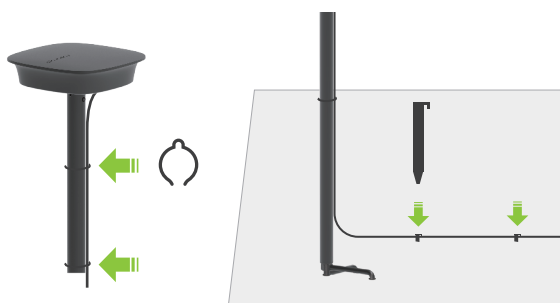

- ⚠ To maintain proper satellite reception, do not move the RTK reference station while the mower is operating, and do not place any objects on or over the antenna.

Charge the Mower for the First Time

We recommend fully charging the mower before first use to ensure optimal battery performance. Place the mower on the charging station, and ensure the charging contacts on both the mower and the station are properly aligned. If the connection is successful, the indicator on the station will breathe green.



Map Out the Working Area

- ⚠ Please follow the mower during the mapping process. Always maintain proper balance and secure footing, especially on slopes. Walk—do not run—when operating the mower.

- Ensure the mower is powered on, WiFi and Bluetooth are connected.
- Before initiating the mapping process, ensure that you have carefully inspected the lawn area and clearly defined the working area. Once the area is defined, follow the mapping instructions provided in the app.
- The mower will travel along the boundary of the designated area and record the map accordingly.

Ready for Mowing

- ⚠ Always ensure your mower is operated within the mapped working area.

Start Mowing

Press then confirm with to start mowing. Alternatively, you can start mowing via the app.



Pause

Press to pause the mower or pause it via the app.

Note: The button overrides all other commands. If you press on the mower, you can only resume mowing by pressing then confirming with on the control panel.

Resume Mowing

Press then confirm with on the control panel or use the app to resume mowing.

In the following situations, the mower can only be resumed by pressing , then confirm with .

- The mower was stopped by pressing .
- The mower was tilted or lifted.

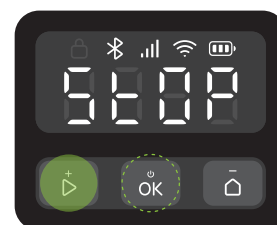

Return to Charge

You can send the mower back to the charging station by pressing and confirming with or via the app.

Note: For the health of your lawn, we do not recommend mowing while the sprinklers are on.

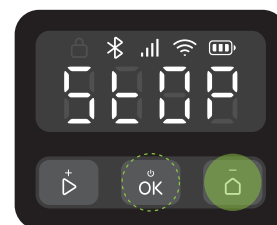

Maintenance

- ⚠ Always wear enclosed footwear and full-length pants during maintenance. Sandals and bare feet are strictly prohibited.

To maintain satisfactory mowing performance and extend your mower's lifespan, the mower requires weekly inspections and maintenance.

Cleaning

- ⚠ Do not use gasoline, alcohol, or other corrosive solvents to clean any parts of the product.
- ⚠ Refrain from rinsing the bottom with a high-pressure washer with pressure higher than 12.0 MPa.

Clean the mower regularly (as needed) to remove dirt and grass clippings from the wheels, cameras, discs.

Before cleaning, please make sure that:

- The mower is powered off.
- The screws of the compartment cover are fully tightened to seal the mower.

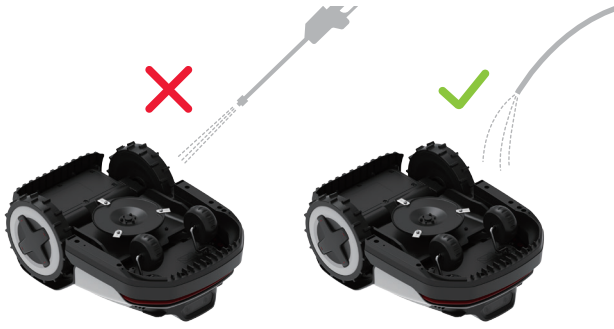

Upper Body

Remove built-up dirt using a hose, cloth, or brush.

Binocular Camera

Regularly check and clean the camera lens using a soft, dry cloth. A clean lens is essential for optimal vision and performance.

Charging Contacts

Clean up the charging contacts on the mower with a soft cloth.



Note: Make sure the contacts have completely dried before restarting the mower.

Bottom Section

- ⚠ Wear work gloves for protection.

Gently turn the mower over on a soft surface. Remove the debris and grass clippings using brushes or water hose. Clean the disc and chassis thoroughly. Rotate the disc and blades to ensure it works properly. Remove any debris to prevent damaging the blade disc.



Note: Be careful not to touch the blades with your hands.

Wheels

Remove mud and grass clippings using brushes and a water hose to ensure the mower maintains good traction.

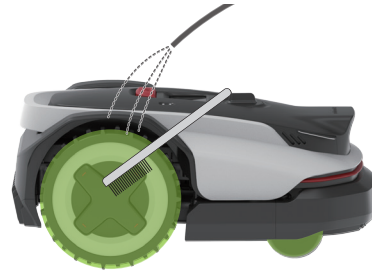

Charging Station

- ⚠ Unplug the charging station from the power outlet before cleaning it.

Clean up the dirt on the charging contacts and the docking markers with a cloth. And clean the charging base plate with a hose.



Note: Make sure the contacts have completely dried before restarting the mower.

Replacing

Blades

- ⚠ Be careful when replacing the blades and always wear gloves.
- ⚠ Make sure all the blades and screws are replaced. Never reuse the screws — doing so may lead to blade detachment and serious injury.

1. Power off the mower.
2. Gently turn the mower over on a soft surface.



3. Loosen the screws and remove the old blades carefully. Mind the sharp edges.
 4. Tighten the new blades with manual screwdrivers.
- ⚠ Never use an electric screwdriver to remove or install the blade.

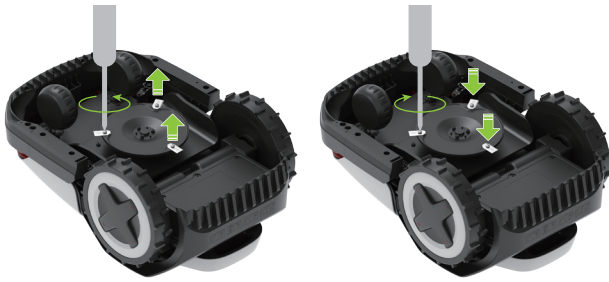

5. Make sure the blades are tightened firmly and can rotate freely.
6. If the blades cannot rotate freely, loosen the screws, adjust the blade angle, then retighten the screws. Ensure the blades can rotate freely before use.

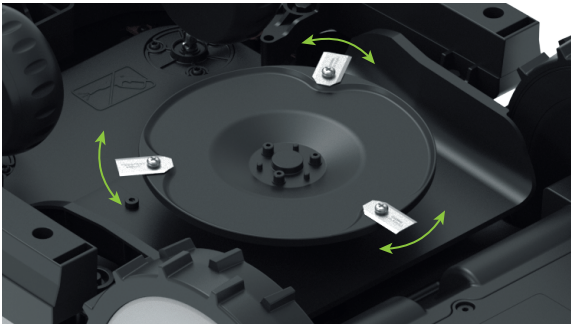

Note: We recommend you replace the blades every 1-2 months after installation.

Battery

We recommend that the battery of the mower should be replaced every two years. Do not replace the battery on your own. Contact our after-sales team or dealer for help.

Long-Term Storage

If the mower is not in use for an extended period (e.g. during the winter when the grass is dormant or for other reasons), please follow these steps:

Mower

1. Charge the mower to 50-70% before storing it long term. Recharge it after 12 months if still in storage, and then once a year thereafter.
2. Power off the mower.
3. Clean it thoroughly.

Station

1. Unplug the battery charger from the power outlet.
2. Disconnect the extension cables from the station.
3. Disconnect the charging tower from the charging base plate, and store it in a dry, well-ventilated indoor location.

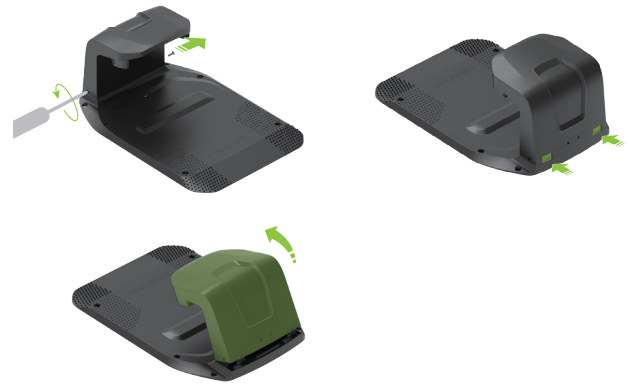

Note: We recommend keeping the charging base plate in its original position. If it is moved, you need to map out the working area again.

Restart after Long-Term Storage

When it is time to restart the mower after long-term storage, please follow the steps below:

1. Ensure the charging station and its accessories are clean and free of oxidation. If any signs of oxidation are found, please contact your Roborock dealer or after-sales service.
2. Refer to "Preparation and Installation > Install the Charging Station" to install the charging tower and connect the battery charger.
3. Power on the mower and check if it is connected to the app successfully.

Troubleshooting

If you encounter any problems while using your mower, check out the FAQ or Error articles at

<https://garden-support.roborock.com> or from the section on the Roborock app.

Technical Data

EN

Basic Information	Name	Q110H
	Model	RRTR1BUT
	Recommended Mowing Area	1/4 acre
	Net Weight (Battery included)	12.3 kg (27.12 lbs.)
Parameter	Cutting Width	22 cm (8.66 in)
	Cutting Height	40-80 mm (1.57-3.15 in)
	Driving Motor Speed	0.4 m/s (1.31 ft/s) (Daily) 0.6 m/s (1.97 ft/s) (Efficient)
	Blade Motor Speed	2600/min
Noise Emissions	Measured Sound Power Level, LWA	59 dB (A)
	Sound Power Uncertainties, KWA	3 dB (A)
	Sound Pressure Level, LpA	51 dB (A)
	Sound Pressure Uncertainties, KpA	3 dB (A)
Working Condition	Temperature	Working Temperature: 0-45°C (32-113°F); 10-35°C (50-95°F) recommended Storage Temperature: -20-55°C (-4-131°F); 10-35°C (50-95°F) recommended
	IP Rating	Mower Body & Charging Station: IPX6 RTK Reference Station: IPX5 Battery Charger: IP67
Battery	Battery Type	Lithium-ion battery
	Nominal Voltage	21.6 V ⁻⁻⁻
	Nominal Capacity	4.6 Ah
	Battery Charging Current	3 A Max.
	Temperature	Charging temperature: 4-45°C (39.2-113°F); 10-35°C (50-95°F) recommended Storage temperature: -20-55°C (-4-131°F); 10-35°C (50-95°F) recommended
Charging Station	Input Voltage	32 V ⁻⁻⁻
	Input Current	2.82 A
	Output Voltage	32 V ⁻⁻⁻ /5.2 V ⁻⁻⁻
	Output Current	2.5 A/1 A
Battery Charger	Model	TZAL02
	Input Voltage	100-240 V~
	Output Voltage	32 V ⁻⁻⁻
	Output Current	2.82 A
RTK Reference Station	Model	MBS00RR
	Input Voltage	5.2 V ⁻⁻⁻
	Input Current	1 A

Environment Protection Information

Removing the Battery

* The following information applies only when disposing of the machine and should not be followed for day-to-day operations.

The chemical substances contained in the built-in lithium-ion battery of this product can cause environmental pollution. Remove the battery before disposing of this product and hand it to a professional battery recycling facility for centralized disposal.

How to remove the battery:

1. Gently turn the mower over onto a soft surface.
2. Loosen the screws on the battery compartment cover.
3. Remove the battery compartment cover.
4. Disconnect the two battery cables connected to the previous battery and remove it from the compartment.

Notes:

- Before removing the battery, make sure it is fully drained and the machine is disconnected from the charging station.
- The screws on the battery compartment cover are captive and fixed to the cover. Do not try to remove them completely—just loosen them until the cover can be lifted off.
- Remove the entire battery pack. Avoid damaging the battery pack casing to avoid short circuits or leakage of hazardous substances.
- In the event of accidental contact with battery fluid, rinse thoroughly with water and seek immediate medical care.

FCC/IC Statement

Compliance Information	
Product Name	Robotic Lawn Mower and Accessories
Product Model	Robotic Lawn Mower Model: RRTR1BUT RTK Reference Station Model: MBS00RR Charging Station Model: MHBJ00RR Battery Charger Model: TZAL02
Compliance Statement	This device complies with Part 15 of the FCC Rules. Operation is subject to the following two conditions: (1) this device may not cause harmful interference, and (2) this device must accept any interference received, including interference that may cause undesired operation. This device contains licence-exempt transmitter(s)/receiver(s) that comply with Innovation, Science and Economic Development Canada's licence-exempt RSS(s). Operation is subject to the following two conditions: (1) This device may not cause interference. (2) This device must accept any interference, including interference that may cause undesired operation of the device.
Correspondence of the Responsible Party in USA	
Company	Roborock Technology Co.
Address	ROOM 1227, 12TH FLOOR, 1000 N. WEST STREET, WILMINGTON, DE 19801
Email	support-us@garden.roborock.com