



RockMow Z120 LiDAR

Robotic Lawn Mower User Manual

Read this user manual carefully before using this product and store it properly for future reference.



Original instructions.

This is a multilingual manual prepared with English as the base language. In case of any discrepancies between the English and other language versions, the English version shall prevail.

EN

Images are for illustration purposes only and may not exactly represent the product.

English

Contents

005	Product Overview
009	Preparation and Installation
011	Ready for Mowing
011	Maintenance
013	Long-Term Storage
013	Troubleshooting
013	Laser Safety
014	Technical Data
015	EU Declaration of Conformity

Product Overview

- ⚠ The mower is pre-installed with blades at its bottom. Always wear protective gloves when lifting the mower, and ensure the blade side is facing outward.
- ⚠ To avoid pinching, keep your hands away from any gaps on the mower while moving it.



Mower

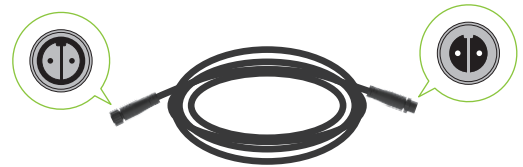

Extension Cable for Battery Charger

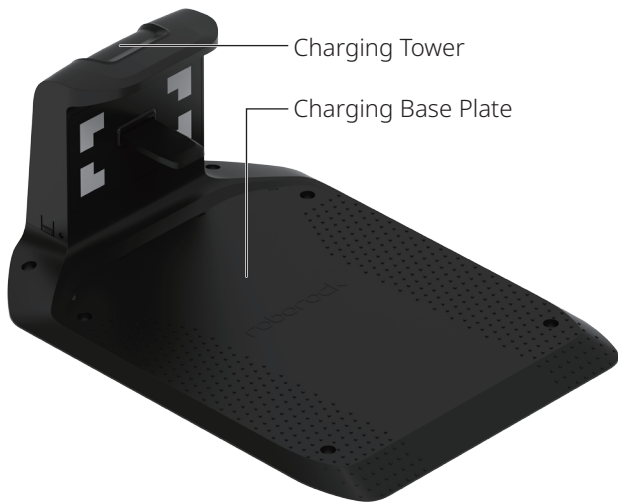

Charging Station

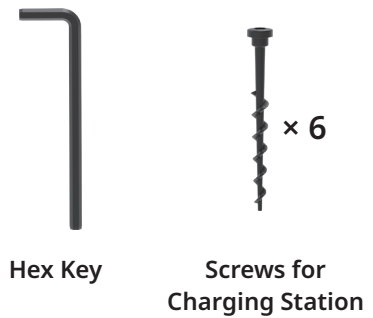

Hex Key

Screws for Charging Station

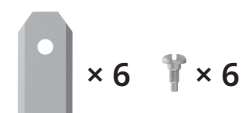

Spare Blade Kit



Battery Charger



Lint-Free Cloth

Robotic Mower (Top View)

EN

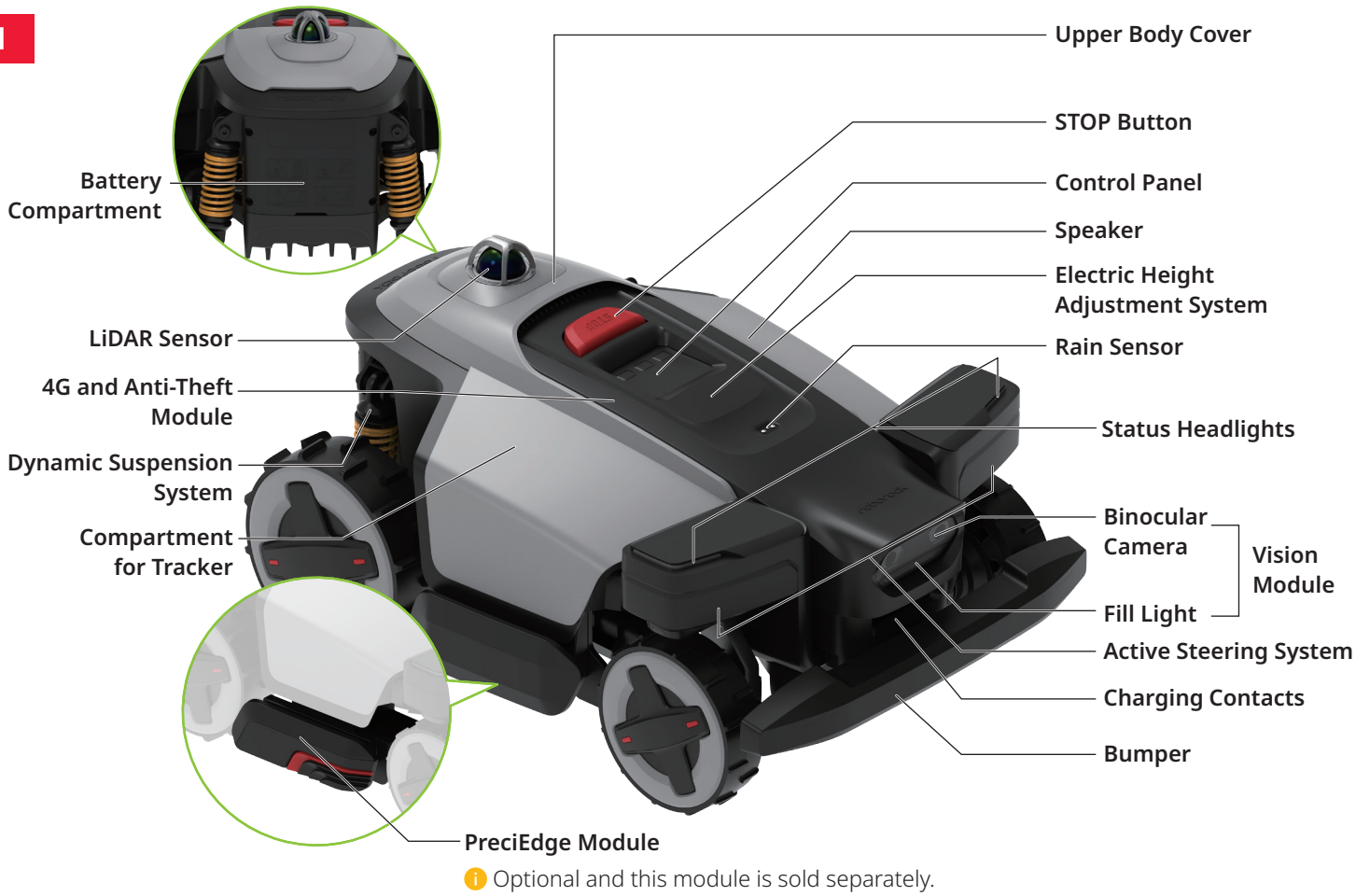

Robotic Mower (Bottom View)

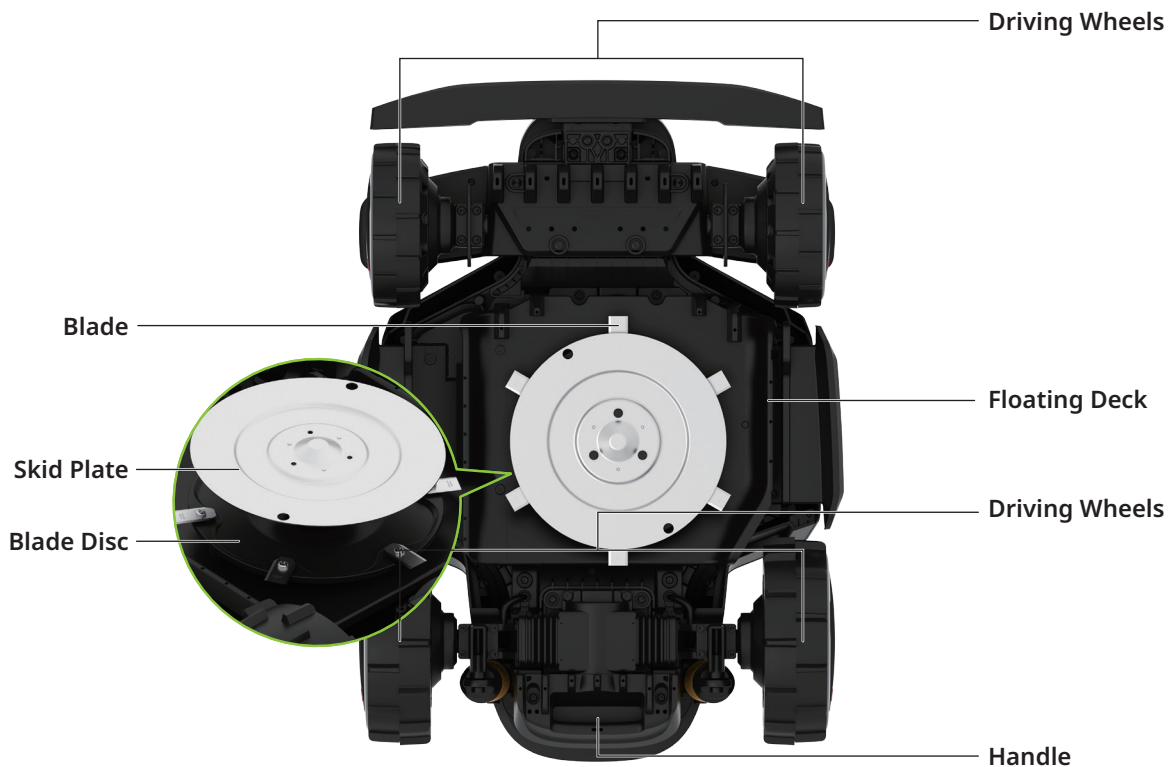

User Interface

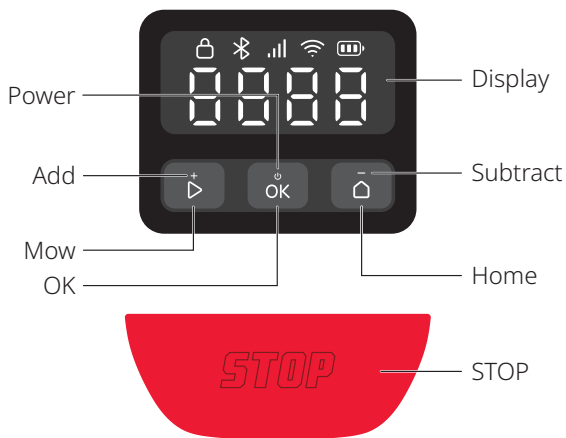

Icon and display	Description
	Battery Level
	4G <ul style="list-style-type: none"> On: 4G available Off: No signal Flashing: 4G and anti-theft module error
	WiFi <ul style="list-style-type: none"> On: Connected Off: No signal/Not connected Flashing: Waiting for WiFi connection Flashing quickly: Connecting
	Bluetooth <ul style="list-style-type: none"> On: Connected Off: Disconnected
	Lock <ul style="list-style-type: none"> On: Mower locked/Child lock enabled Off: Mower unlocked/Child lock disabled Breathing: Typing PIN code



STOP
Mower stopped.

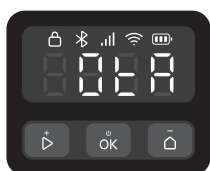

OTA
Over-the-air (OTA) updating.





Error code
A code like this indicates the mower has encountered an error. You can refer to "Error" article at <https://garden-support.roborock.com> or from the section on the Roborock app for solutions.

Icon and display	Description
	Powering on/off The outer segments rotate clockwise in a continuous loop.
	Charging The display will show battery level in digits.
	Mowing/Mapping/Returning The four digits form a pattern as shown in the diagram. Each segment of the pattern lights up sequentially. Once the full pattern is displayed, the sequence repeats.
	TILT Mower tilted.
	LIFT Mower lifted.

Control

Control	Description
Power on/off	Press and hold for 3 seconds.
Start mowing	Press and then confirm with .
Stop the mower	Press .
Send the mower back to the charging station	Press and then confirm with .
Enable the child lock	Press and hold for 5 seconds.
Unlock the mower/Disable the child lock	Press any button, then enter the PIN code.
Pair the mower	Press and hold and simultaneously for 3 seconds.
Restore factory settings	Press and hold , , and simultaneously for 10 seconds, and then enter the PIN code.
Restart the mower	Press and hold for 10 seconds.



How to Enter PIN Code

Enter the PIN code to unlock the mower before operating. The default code is 0000, you can change the code via the app. Press  or  to increase or decrease the number and press  to confirm each digit.

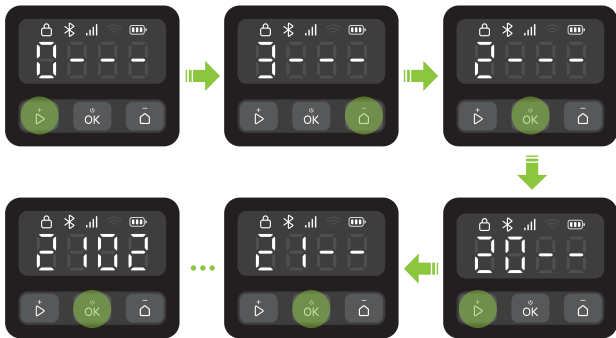
Note: Please keep the PIN code secure and do not disclose it to others.



Indicator on Charging Station

Indicator status	Description
 Steady green	Mower uncharged.
 Breathing green	Mower is charging.
 Steady red	Charging station error.
/ Off	<ul style="list-style-type: none"> Mower fully charged. Circuit fault.

Status Headlights

Light color	Light effect	Description
/	Off	<ul style="list-style-type: none"> Mower is charging. Mower on standby outside station.
White	Flowing	Power on/off.
	Breathing quickly	OTA updating.
	Breathing slowly	Mower has paused.
	Steady	<ul style="list-style-type: none"> Mapping. Mowing. Returning to charge.
Blue	Breathing slowly	Waiting for connection.
	Breathing quickly	Connecting.
Red	Breathing quickly	Error.

Sensors

Sensor	Description
Binocular camera	Senses its surroundings, performs different actions in response to various objects ahead, and runs fusion algorithms with other sensors.
LiDAR sensor	Uses LiDAR for precise positioning, enabling the mower to accurately determine its location.
GNSS Module	Uses GNSS for positioning, enabling the user to know the mower's location.

How It Works

Your robotic lawn mower can automatically switch between mowing and charging. It does not require a boundary wire to define the working area, due to its LiDAR sensor and smart mapping with a binocular camera. With a multi-sensor fusion algorithm and a wide detection range, the mower intelligently navigates corners and safely avoids obstacles.

Auto Docking

The mower automatically returns to the charging station when it runs low on power. After charging for a while, the mower will resume mowing.

All Day Cut

The camera's fill light enables the mower to operate at night. You can also set the mower to be wildlife-friendly via the app.

Schedule

You can set your mowing schedule in the app, and the mower will operate automatically according to it.

Cutting Height

Before starting mowing, make sure your grass is no longer than your regular maintenance height. The mower offers multiple adjustable cutting heights.

Planned Route

The mower follows a parallel route generated by a routing algorithm, ensuring higher efficiency and leaving users more time to enjoy their lawn.

Smart Obstacle Avoidance

With its binocular camera and LiDAR sensor, the mower can detect and identify various types of objects, execute different routes accordingly, and balance safety and mowing coverage.

Adapting to Various Obstacles and Terrains

The mower is equipped with an all-wheel drive system and a dynamic suspension system, which enhance its climbing ability, improve obstacle-crossing performance, and provide stable movement on uneven terrain for consistent cutting performance.

Active Steering System

With a front-wheel steering system, the mower features zero-turn capability for agile movement, offering efficient coverage of the lawn (even on a slope) while reducing damage to the lawn.

Rain Sensor and Rain Delay

The mower is IPX6-rated water-resistant and built for outdoor use. However, mowing wet grass may not deliver the best results. The mower is equipped with a rain sensor which detects rain and tells the mower to stop mowing and go back to its charging station. It then re-starts mowing after Rain Delay time (180 min by default). You can change the Rain Delay time setting via the app.

Floating Deck

The mower's floating deck allows the mower to dynamically adapt to changes in terrain, ensuring a more even and consistent cut across uneven surfaces.

No Need to Collect Grass Clippings

The short clippings left behind do not need to be raked or collected, as they serve as natural fertilizer for your lawn.

PreciEdge Module

i This module needs to be purchased separately.

With its innovative dual-blade design, the mower can cut close to walls, reducing manual edging.

Anti-Theft

The mower comes with a built-in high-pitched alarm and a 4G and anti-theft module. It also includes a compartment for tracker where you can install a tracker (sold separately).

Preparation and Installation

Prepare the App

1 Download the App

Scan the QR code to install the Roborock app.



2 Prepare Your Phone

Before proceeding, make sure your phone's Bluetooth is turned on, which is essential for finding and linking your mower during the setup process.

3 Connect the Mower

1. Press and hold **OK** for 3 seconds to power on the mower and enter the PIN code. The default code is 0000.
2. Open the Roborock app.
3. Scan the QR code on the mower via the app or press and hold the **▶** and **⏸** buttons simultaneously for 3 seconds to connect.

Notes:

- We recommend connecting to a 2.4 GHz WiFi network.
- Ensure your mower is within Bluetooth connectable distance (6 m/19.69 ft).

Prepare the Lawn

Before mowing, cut your lawn to its regular maintenance height. Remove any debris, toys, wires, stones, or other obstacles. Ensure that children and pets are kept off the lawn.

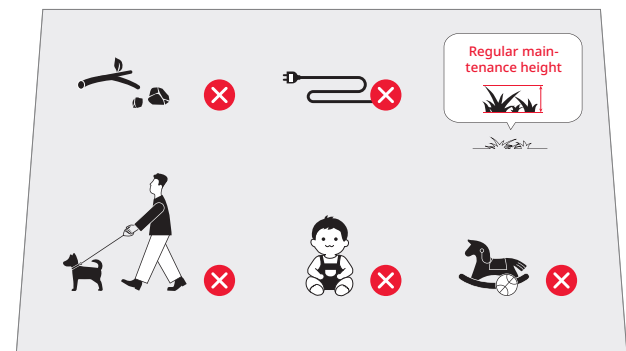

Install the Charging Station

Find a Proper Location

It is important to choose a suitable place for the charging station to ensure effective docking of the mower. See guide below:

1. The charging station should be placed on a flat surface in an open area and close to the battery charger (within 10 m/32.81 ft).



2. We recommend you place the station where the WiFi signal is strong.



3. Within a 2-meter (6.56 feet) radius around the charging station, there should be no obstacles, and the grass should be less than 9 cm (3.54 in) high.

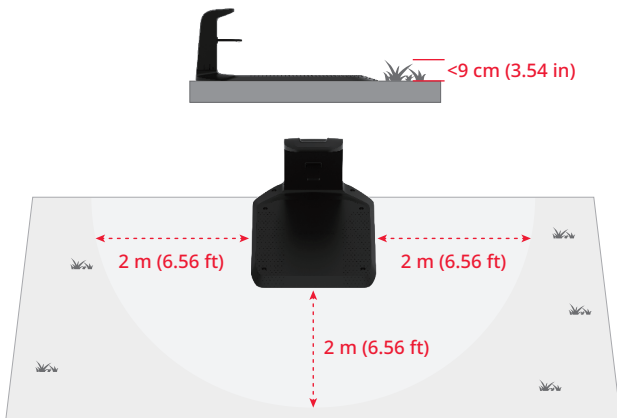

4. The docking markers on the charging tower should be clearly visible, and the charging base plate should be clear of any objects or debris.

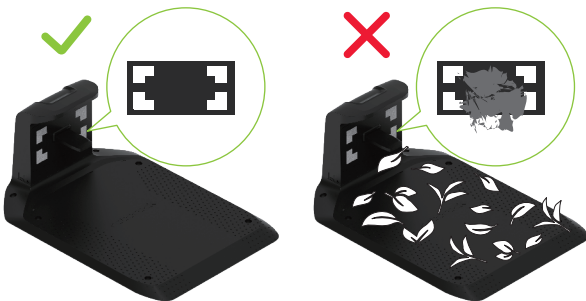

Install the Charging Station

1. Secure the charging base plate to the ground using the provided screws and hex key.

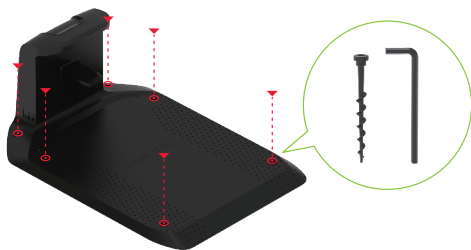

2. Use the extension cable to connect the charging station to the battery charger. You need to align the 2-pin connector, insert it fully, and tighten the locking ring to finish connecting.

3. Connect the battery charger to the power outlet.

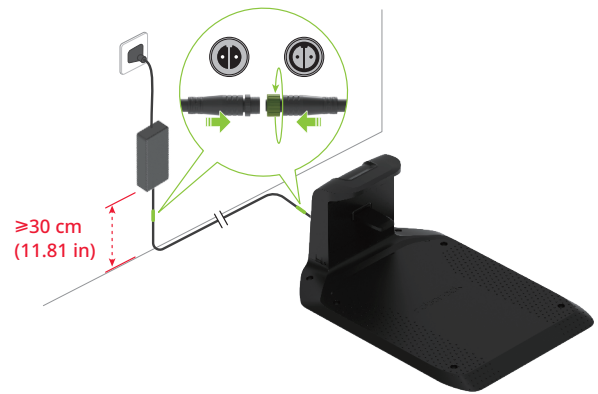

Notes:

- If you need to disconnect the extension cable, loosen the locking ring first, then pull out the connector.
- Ensure the battery charger is positioned at least 30 cm (11.81 in) above the ground to prevent water or moisture damage.
- Plug the device into an indoor outlet or an outdoor waterproof outlet.

4. If the setup is correct, the indicator on the charging station will light green.



Charge the Mower for the First Time

We recommend fully charging the mower before first use to ensure optimal battery performance. Place the mower on the charging station, and ensure the charging contacts on both the mower and the station are properly aligned. If the connection is successful, the indicator on the station will breathe green.



Map Out the Working Area



⚠ Please follow the mower during the mapping process. Always maintain proper balance and secure footing, especially on slopes. Walk—do not run—when operating the mower.

1. Ensure the mower is powered on, WiFi and Bluetooth are connected.
2. Before initiating the mapping process, ensure that you have carefully inspected the lawn area and clearly defined the working area. Once the area is defined, follow the mapping instructions provided in the app.
3. The mower will travel along the boundary of the designated area and record the map accordingly.

Ready for Mowing

⚠ Always ensure your mower is operated within the mapped working area.



Start Mowing

Press  then confirm with  to start mowing. Alternatively, you can start mowing via the app.







Pause

Press  to pause the mower or pause it via the app.

Note: The  button overrides all other commands. If you press on the mower, you can only resume mowing by pressing  then confirming with  on the control panel.

Resume Mowing



Press  then confirm with  on the control panel or use the app to resume mowing.

In the following situations, the mower can only be resumed by pressing , then confirm with :

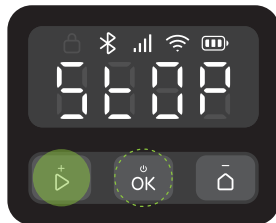
- The mower was stopped by pressing .
- The mower was tilted or lifted.



Return to Charge

You can send the mower back to the charging station by pressing  and confirming with  or via the app.

Note: For the health of your lawn, we do not recommend mowing while the sprinklers are on.

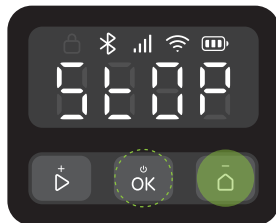

Maintenance

⚠ Always wear enclosed footwear and full-length pants during maintenance. Sandals and bare feet are strictly prohibited.

⚠ Always turn the mower over on a soft surface gently and do not drag the mower while it is upside down.

To maintain satisfactory mowing performance and extend your mower's lifespan, the mower requires weekly inspections and maintenance.

Cleaning

⚠ Do not use gasoline, alcohol, or other corrosive solvents to clean any parts of the product.

⚠ Refrain from rinsing the mower with a high-pressure washer with pressure higher than 12.0 MPa.

Clean the mower regularly (as needed) to remove dirt and grass clippings from the wheels, cameras, discs, LiDAR sensor, etc.

Before cleaning, please make sure that:

- The mower is powered off.
- The screws of the compartment cover are fully tightened to seal the mower.

EN

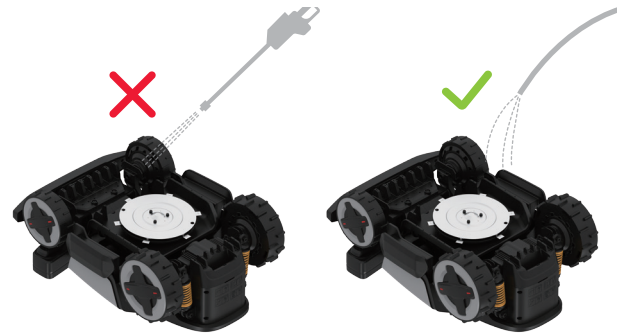

Upper Body

Remove built-up dirt using a hose, cloth, or brush on the active steering system, dynamic suspension system and other parts.

Binocular Camera

A clean lens is essential for optimal vision and performance. Wipe the camera lens with the provided lint-free cloth.



LiDAR Sensor

A clean LiDAR sensor is essential for optimal vision and performance. Clean the sensor as follows:

1. Remove the upper body cover as shown in the picture.



2. Wipe the LiDAR sensor carefully using the provided lint-free cloth. If the LiDAR sensor is still not clear, dampen the sensor first and then wipe it again.

EN

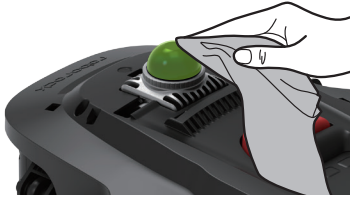

3. Install the upper body cover back onto the mower.



Charging Contacts

Clean up the charging contacts on the mower with a soft cloth.



Note: Make sure the contacts have completely dried before restarting the mower.

Bottom Section

⚠ Wear work gloves for protection.

Gently turn the mower over on a soft surface. Remove the debris and grass clippings using brushes or water hose. Clean the disc and chassis thoroughly. Rotate the disc and blades to ensure they work properly. Remove any debris to prevent damaging the blade disc.

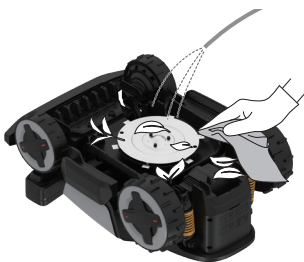

Note: Be careful not to touch the blades with your hands.

Driving Wheels

Remove mud and grass clippings using brushes and a water hose to ensure the mower maintains good traction.

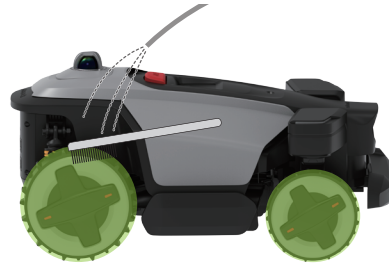

Charging Station

⚠ Unplug the charging station from the power outlet before cleaning it.

Clean up the dirt on the charging contacts and the docking markers with a cloth. And clean the charging base plate with a hose.



Note: Make sure the contacts have completely dried before restarting the mower.

Replacing

Blades

⚠ Be careful when replacing the blades and always wear gloves.

⚠ Make sure all the blades and screws are replaced. Never reuse the screws — doing so may lead to blade detachment and serious injury.

1. Power off the mower.
2. Gently turn the mower over on a soft surface.



- Align the screw holes on the skid plate with the blade screws, then loosen the screws with a manual screwdriver and remove the old blades. Mind the sharp edges.
- Keep the skid plate screw holes aligned with those on the blades and blade disc, then tighten the new blades with new screws.

⚠ Never use an electric screwdriver to remove or install the blade.



- Make sure the blades are tightened firmly and can rotate freely.
- If the blades cannot rotate freely, loosen the screws, adjust the blade angle, then retighten the screws. Ensure the blades can rotate freely before use.



Note: We recommend you replace the blades every 1-2 months after installation.

Battery

We recommend that the battery of the mower should be replaced every two years. Do not replace the battery on your own. Contact our after-sales team or dealer for help.

Long-Term Storage

If the mower is not in use for an extended period (e.g. during the winter when the grass is dormant or for other reasons), please follow these steps:

Mower

- Charge the mower to 50–70% before storing it long term.
- Power off the mower.
- Clean it thoroughly.

Note: Recharge it after 12 months if still in storage, and then once a year thereafter.

Station

- Unplug the battery charger from the power outlet.
- Disconnect the extension cables from the station.
- Disconnect the charging tower from the charging base plate, and store it in a dry, well-ventilated indoor location.

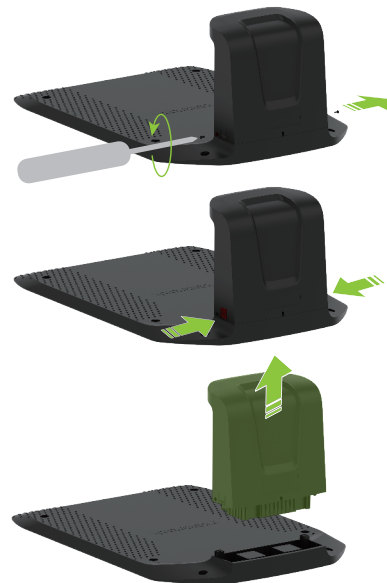

Restart after Long-Term Storage

To restart the mower after long-term storage, please follow the steps below:

- Ensure the charging station and its accessories are clean and free of oxidation. If any signs of oxidation are found, please contact your Roborock dealer or after-sales service.
- Insert the charging tower into the charging base plate. Tighten the screws on both sides of the charging tower.
- Connect the extension cables, power on the mower, and check if it is connected to the app successfully.

Troubleshooting

If you encounter any problems while using your mower, check out the FAQ or Error articles at <https://garden-support.roborock.com> or from the section on the Roborock app.

Laser Safety

The laser distance sensor of this product meets the standards for Class 1 Laser Products in IEC 60825-1:2014 and will not generate hazardous laser radiation.

Technical Data

EN

Basic Information	Name	Z120 LiDAR
	Model	RRALOVER
	Recommended Mowing Area	2000 m ²
	Net Weight (Battery included)	Approx. 21.7 kg (47.84 lbs.)
Parameter	Cutting Width	24 cm (9.45 in)
	Cutting Height	20-70 mm (0.79-2.76 in)
	Driving Motor Speed	0.45 m/s (1.48 ft/s) (Daily) 0.6 m/s (1.97 ft/s) (Efficient)
	Blade Motor Speed	2500/min
Noise Emissions	Measured Sound Power Level, LWA	62 dB (A)
	Sound Power Uncertainties, KWA	3 dB (A)
	Sound Pressure Level, LpA	54 dB (A)
	Sound Pressure Uncertainties, KpA	3 dB (A)
Working Condition	Temperature	Working Temperature: 0-45°C (32-113°F); 10-35°C (50-95°F) recommended Storage Temperature: -20-55°C (-4-131°F); 10-35°C (50-95°F) recommended
	IP Rating	Mower Body & Charging Station: IPX6 Battery Charger: IP67
Connectivity Frequency Range	Bluetooth®	2400-2483.5 MHz
	WiFi	2.4GHz: 2400-2483.5 MHz 5GHz Sub-band 3: 5470-5725 MHz 5GHz Sub-band 4: 5725-5850 MHz
	LTE	Band 1/3/7/8/20/28A/38/40/41
	WCDMA	Band 1/8
	GSM	EGSM900 DCS1800
Max. Radio-frequency Power	Bluetooth®	≤10 dBm
	WiFi	2.4 GHz: ≤20 dBm 5 GHz Sub-band 3: ≤20 dBm 5 GHz Sub-band 4: ≤14 dBm
	LTE	≤23 dBm
	WCDMA	≤23 dBm
	GSM	≤35 dBm ≤32 dBm
Battery	Battery Type	Lithium-ion battery
	Nominal Voltage	21.6 V ⁻⁻⁻
	Nominal Capacity	6 Ah
	Battery Charging Current	5 A Max.
	Temperature	Charging temperature: 4-45°C (39.2-113°F); 10-35°C (50-95°F) recommended Storage temperature: -20-55°C (-4-131°F); 10-35°C (50-95°F) recommended
Charging Station	Input Voltage	32 V ⁻⁻⁻
	Input Current	4.69 A
	Output Voltage	32 V ⁻⁻⁻
	Output Current	4 A
Battery Charger	Model	TZAM01
	Input Voltage	100-240 V~
	Output Voltage	32 V ⁻⁻⁻
	Output Current	4.69 A

EU Declaration of Conformity

Hereby, Suzhou ShiRuizhuo Technology Co., Ltd. declares that this equipment is in compliance with Machinery Directive 2006/42/EC. The full text of the EU declaration of conformity is available at the following internet address:

<https://garden.roborock.com/eu/policy/article/compliance>

EN

Name of manufacturer	Suzhou ShiRuizhuo Technology Co., Ltd.
Address	Room 508, Building C, No.112 GLP I-Park, Sutong Road, Suzhou Industrial Park District, Suzhou City, Jiangsu Province, P.R. China
Name of authorized representative	Roborock International B.V.
Address	Strawinskylaan 3051, Atrium, 1077ZX Amsterdam

Hereby we declare that this DoC is issued under the sole responsibility of the company Suzhou ShiRuizhuo Technology Co., Ltd. and that the products:

Product description	Robotic Lawn Mower
Type(model) designation(s)	RRALOVER
Serial No.	RXXXXXXXXXX ("X" indicates any letter from A-Z except O and I, "Y" indicates any number from 0-9)

are in conformity and verified through testing with the provision of the following EU directives:

Machinery Directive 2006/42/EC	1. EN 60335-1:2012 + A11:2014 + A13:2017 + A1:2019 + A14:2019 + A2:2019 + A15:2021 +A16:2023 2. EN 50636-2-107:2015+A1:2018+A2:2020+A3:2021 3. EN ISO 12100:2010
--------------------------------	--

Person responsible for making this declaration:

Printed name: Dollar Qian

Position/Title: Certification Manager

Signature: 

Date of issue: 2026-01-06

Place of issue: Room 508, Building C, No.112 GLP I-Park, Sutong Road, Suzhou Industrial Park District, Suzhou City, Jiangsu Province, P.R. China